

Quick Installation Guide

IAP-W420+ / W422+







Industrial IP-67 PoE Outdoor Access Point

Introduction

The IAP-W420+/W422+ is a reliable IP-67 outdoor IEEE 802.11 b/g/n WLAN access point with two 10/100Base-T(X) P.D. Ethernet ports. It can be configured to operate in AP/Client/AP-Client/Bridge modes and is specifically designed for the toughest industrial environments. The combination of an IP-67 design and superb management functionality, the IAP-W420+/W422+ provides a waterproof, dust-tight connection. In addition, IAP-W420+ provides a high power output of 800mw and throughput up to 80Mbps to satisfy long distance connections. The IAP-W422+ provides two N-type connectors for any N-type antennas to extend communication distances. You are able to configure the device by Web interface via the LAN port or by WLAN interface. In addition, the device provides P.D. feature which is fully compliant with IEEE802.3af PoE standard to save the layout cost of power line. The device can be easily adopted in almost all kinds of applications and provides the most rugged solutions for managing your network in outdoors.

Package Contents



The device is shipped with the following items. If any of these items is missing or damaged, please contact your customer service representative for assistance.



Contents	Pictures	Number
IAP-W420+/ IAP-W422+		X 1
CD		X 1
N-type ANT. Rubber Seal		X 2 (IAP-W422+ only)
RJ-45 Rubber Seal		X 2
Pole Mount Kit		X 2
QIG		X 1

Preparation

Before installation, make sure you have all of the package contents available and a PC with Microsoft Internet Explorer 6.0 or later, for using web-based system management tools.

Safety & Warnings

-  When installed outdoors, make sure the LAN ports are covered by RJ-45 rubber seals provided with the package.
-  Do not remove the water-proof casing, and avoid touching or moving the device when the antennas are transmitting or receiving.

-  When installing the device, make sure to keep the radiating at a minimum distance of 20 cm (7.9 inches) from all persons to minimize the potential for human contact during normal operation.
-  Do not operate the device near unshielded blasting caps or in an otherwise explosive environment unless the device has been modified for such use by qualified personnel.

Dimension

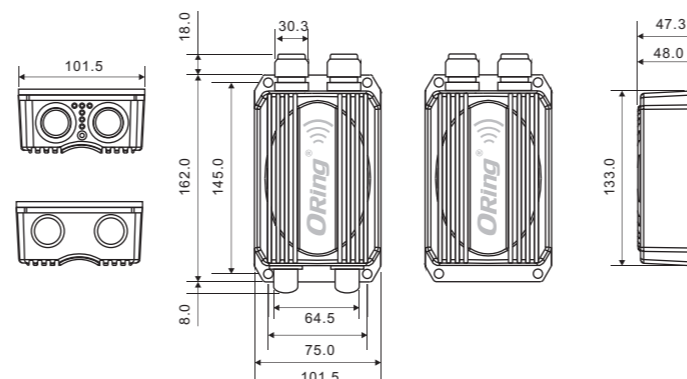

Panel Layouts

Front Panel

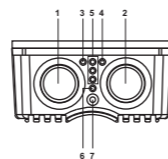

1. Non-PoE LAN port
2. PoE LAN port
3. LNK/ACT LED for non-PoE LAN port
4. LNK/ACT LED for PoE LAN port
5. WiFi connections (weakest signal strength at the bottom, strongest at the top)
6. Power indicator
7. Reset button

Rear Panel

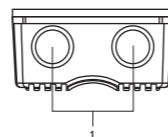

1. N-type antenna connectors

Installation

The device can be fixed to a pole or the wall using the supplied mounting kits. Before installing the device, make sure you have all of the package contents available and a PC with Microsoft Internet Explorer 6.0 or later, for using web-based system management tools.

Pole mounting

You can mount the device to a pole using adjustable steel band straps included in the package.

Thread the two supplied metal mounting straps through the screw holes on the edge of the unit and then put the straps around the pole, as shown below. Put the washers and nuts through the straps and tighten the strap.

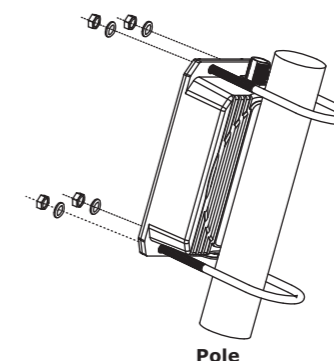

Network Connection

The device has two 10/100Base-T(X) Ethernet ports. According to the link type, the AP uses CAT 3, 4, 5, 5e, 6UTP cables to connect to any other network device (PCs, servers, switches, routers, or hubs).

Cable	Type	Max. Length	Connector
10Base-T	Cat. 3, 4, 5 100-ohm	UTP 100 m (328 ft)	RJ45
100Base-TX	Cat. 5 100-ohm UTP	UTP 100 m (328 ft)	RJ45

10/100Base-T(X) RJ-45 Port Pin Assignments	
Pin Number	Assignment
1	TD+
2	TD-
3	RD+
4	N.C.
5	N.C.
6	RD-
7	N.C.
8	N.C.

Power Supply

The device is powered by an Ethernet cable via the PoE port, which is on the right hand side. Make sure the PoE port is connected with an RJ-45 cable and check if the power LED lights up after connection.

Configurations

After connecting an Ethernet cable to the PoE port, the green power LED should turn on. Please refer to the following table for LED indication.

LED	Color	Status	Description
PWR	Green	On	PoE power is on and power supply in normal function
ETH	Green	On	Port is linked
		Blinking	Transmitting data
WLAN	Green	On	WLAN activated (WLAN strength: 1<30%, 2<60%, 3<90%)
		Blinking	Transmitting data via WLAN

Follow the steps below to log in and access the system:

1. Launch the Internet Explorer and type in IP address of the device. The default static IP address is **192.168.10.2**



2. Log in with default user name and password (both are admin). After logging in, you should see the following screen. For more information on configurations, please refer to the user manual. For information on operating the device using ORing's Open-Vision management utility, please go to ORing website.



Resetting

For protection, the reset button is placed in the case covered by a screw head. If you need to reset the device, remove the screw and use a very small point object like a needle or a toothpick to poke the reset button. To restore the device configurations back to the factory defaults, press the **Reset** button for 5 seconds.

Specifications

ORing WLAN Access Point Model	IAP-W420+	IAP-W422+
Physical Ports		
10/100 Base-T(X) Ports in RJ45 Auto MDI/MDIX	2	
WLAN Interface		
Operating Mode	AP/Client/AP-Client/Bridge	
Antenna and Connector	Build-in 10dBi panel antenna	2 x External N-type antenna connector
Radio Frequency Type	OFDM	
Modulation	IEEE802.11b/g/n: CCK, DQPSK, DBPSK IEEE802.11g/n : OFDM with BPSK, QPSK, 16-QAM, 64-QAM	
Frequency Band	America / FCC : 2.412~2.462 GHz (11 channels) Europe CE / ETSI : 2.412~2.472 GHz (13 channels)	
Transmission Rate	IEEE802.11b: 11, 5.5, 2, 1 Mbps IEEE 802.11g: 54, 48, 36, 24, 18, 12, 9, 6 Mbps IEEE 802.11n: up to 300Mbps	
Transmit Power	IEEE802.11b/g/n: 800mw(29dbm) max.	
Receiver Sensitivity	-96dBi ± 2dBi	
Encryption Security	WEP: (64-bit, 128-bit key supported) WPA/WPA2: (WEP and AES encryption) 802.11i WPA-PSK (256-bit key pre-shared key supported) 802.1X Authentication supported TKIP encryption	
Wireless Security	SSID broadcast disable	
Protocol Support		
Protocol	ARP, BOOTP, DHCP, DNS, HTTPS, IP, ICMP, SNMP, TCP, UDP, RADIUS, SNMP, STP (IEEE 802.1D)	
Power		
Input power	48VDC from P.o.E port	
Power Consumption(Typ.)	9 watts	
Physical Characteristic		
Enclosure	IP-67	
Dimension (W x D x H)	162 (W) x 101.5 (D) x 58 (H) mm (6.38 x 4.0 x 2.28 inch.)	
Weight (g)	720g	790g
Environmental		
Storage Temperature	-30 to 85°C (-22 to 185°F)	
Operating Temperature	-20 to 70°C (-4 to 158°F)	
Operating Humidity	5% to 95% Non-condensing	
Regulatory Approvals		
EMI	FCC Part 15, CISPR (EN55022) class A	
EMS	EN61000-4-2 (ESD), EN61000-4-3 (RS), EN61000-4-4 (EFT), EN61000-4-5 (Surge), EN61000-4-6 (CS), EN61000-4-8, EN61000-4-11	
Shock	IEC60068-2-27	
Free Fall	IEC60068-2-32	
Vibration	IEC60068-2-6	
Safety	EN60950-1	
Warranty	3 years	

ORing

Copyright© 2014 ORing
All rights reserved.

ORing Industrial Networking Corp.
TEL: +886-2-2218-1066 Website: www.oring-networking.com
FAX: +886-2-2218-1014 E-mail: support@oring-networking.com