







## Introduction

The **IGPS-9842GTP Series** is a full-Gigabit managed PoE Ethernet switches with eight 10/100/1000Base-T(X) P.S.E. ports, four 10/100/1000Base-T(X) ports, and two 100/1000Base-X SFP ports. With complete support for Ethernet redundancy protocols such as O-Ring (recovery time <30ms over 250 units of connection) and MSTP (RSTP/STP compatible), the device can protect mission-critical applications from network interruptions or temporary malfunctions with fast recovery technology. With EN50155 compliance, the device guarantees reliable operation against environmental disturbances, such as vibration and shock, and are ideal for rolling stock applications. The device features eight 10/100/1000Base-T(X) P.S.E. ports which are able to provide sufficient power for those power-hungry devices with up to 30W per port. With a wide operating temperature from -40°C to 70°C, the device can be managed centralized via ORing's proprietary Open-Vision manage utility as well as via Web-based

## Package Contents



The device is shipped with the following items. If any of these items is missing or damaged, please contact your customer service representative for assistance.



Contents	Pictures	Number
IGPS-9842GTP / IGPS-9842GTP-24V		X 1
CD		X 1
DIN-rail Kit		X 1
Wall-mount Kit		X 2
Console Cable		X 1
QIG		X 1

## Preparation

Before you begin installing the switch, make sure you have all of the package contents available and a PC with Microsoft Internet Explorer 6.0 or later, for using web-based system management tools.

### Safety & Warnings

-  **Elevated Operating Ambient:** If installed in a closed or multi-unit rack assembly, the operating ambient temperature of the rack environment may be greater than room ambient. Therefore, consideration should be given to installing the equipment in an environment compatible with the maximum ambient temperature (T<sub>ma</sub>) specified by the manufacturer.
-  **Reduced Air Flow:** Installation of the equipment in a rack should be such that the amount of air flow required for safe operation of the equipment is not compromised.

-  **Mechanical Loading:** Mounting of the equipment in the rack should be such that a hazardous condition is not achieved due to uneven mechanical loading.
-  **Circuit Overloading:** Consideration should be given to the connection of the equipment to the supply circuit and the effect that overloading of the circuits might have on overcurrent protection and supply wiring. Appropriate consideration of equipment nameplate ratings should be used when addressing this concern.

### Dimension

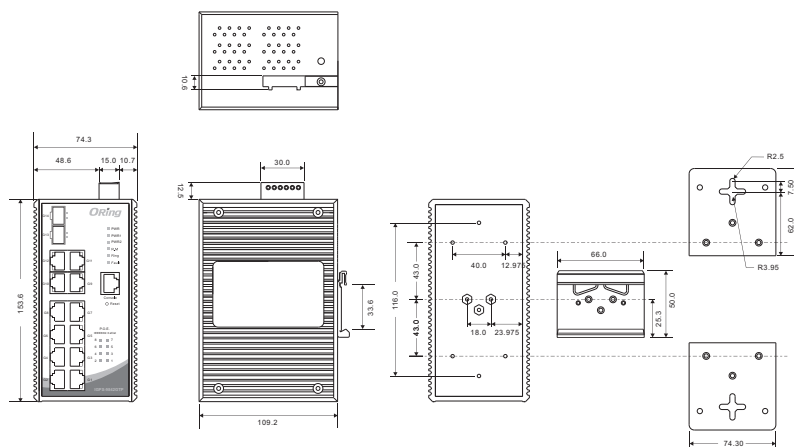

### Panel Layouts

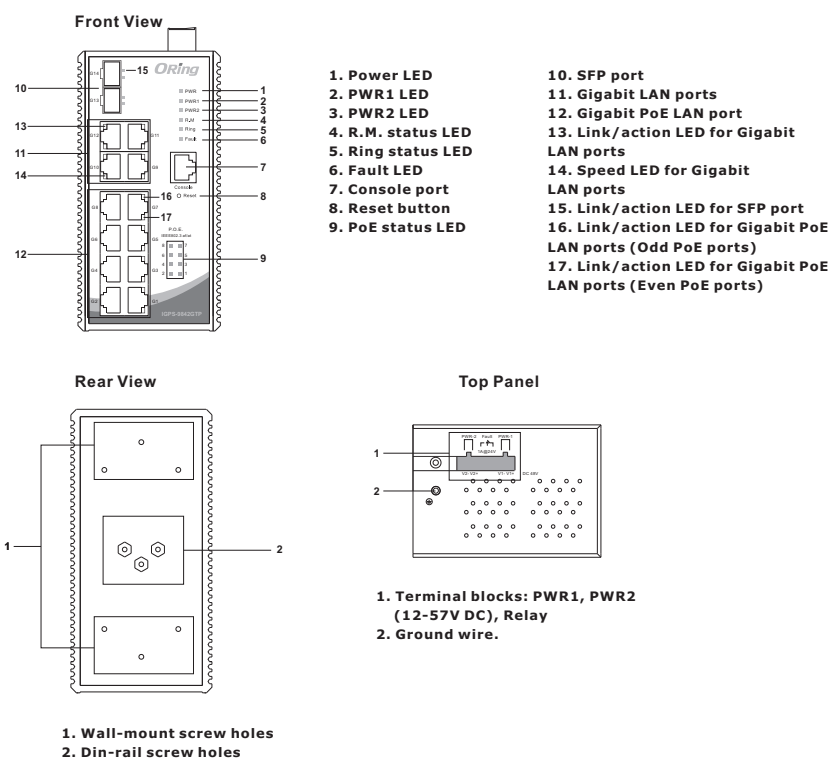

## Installation

### DIN-rail Installation

- Step 1:** Slant the switch and screw the Din-rail kit onto the back of the switch, right in the middle of the back panel.
- Step 2:** Slide the switch onto a DIN-rail from the Din-rail kit and make sure the switch clicks into the rail firmly.

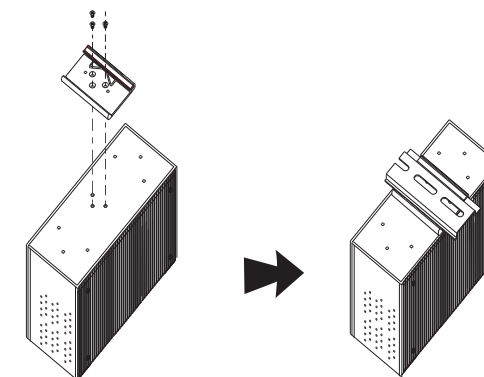

### Wall-mounting

- Step 1:** Screw the two pieces of wall-mount kits onto both ends of the rear panel of the switch. A total of six screws are required, as shown below.
- Step 2:** Use the switch, with wall mount plates attached, as a guide to mark the correct locations of the four screws.
- Step 3:** Insert screws through the round screw holes (the red arrow as below) on the sides or through the cross-shaped aperture (the green arrow as below) in the middle of the plate and fasten the screw to the wall with a screwdriver.
- Step 4:** If the screw goes through the cross-shaped aperture, slide the switch down before tightening the screw.

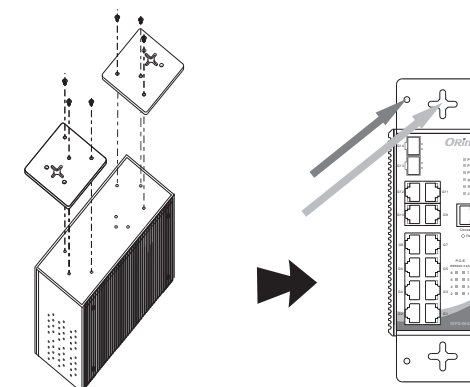

### Network Connection

The switch provides standard Ethernet ports. According to the link type, the switch uses CAT 3, 4, 5, 5e UTP cables to connect to any other network devices (PCs, servers, switches, routers, or hubs). Please refer to the following table for cable specifications.

#### Cable Types and Specifications:

Cable	Type	Max. Length	Connector
10BASE-T	Cat. 3, 4, 5 100-ohm	UTP 100 m (328 ft)	RJ-45
100BASE-TX	Cat. 5 100-ohm UTP	UTP 100 m (328 ft)	RJ-45
1000BASE-T	Cat. 5 / Cat. 5e 100-ohm UTP	UTP 100 m (328 ft)	RJ-45

## Quick Installation Guide

## IGPS-9842GTP Series Industrial Managed PoE Gigabit Switch

For pin assignments for different types of cables, please refer to the following tables.

10/100Base-T(X) P.S.E. RJ-45 Port	
Pin No.	Assignments
# 1	TD+ with PoE Power input +
# 2	TD- with PoE Power input +
# 3	RD+ with PoE Power input -
# 6	RD- with PoE Power input -

1000Base-T P.S.E. RJ-45 Port	
Pin No.	Assignments
# 1	BI_DA+ with PoE Power input +
# 2	BI_DA- with PoE Power input +
# 3	BI_DB+ with PoE Power input -
# 4	BI_DC+
# 5	BI_DC-
# 6	BI_DB- with PoE Power input -
# 7	BI_DD+
# 8	BI_DD-

1000Base-T RJ-45 Port	
Pin Number	Assignment
1	BI_DA+
2	BI_DA-
3	BI_DB+
4	BI_DC+
5	BI_DC-
6	BI_DB-
7	BI_DD+
8	BI_DD-

10/100 Base-T(X) RJ-45 Port	
Pin Number	Assignments
1	TD+
2	TD-
3	RD+
4	Not used
5	Not used
6	RD-
7	Not used
8	Not used

10/100 Base-T(X) MDI/MDI-X		
Pin Number	MDI port	MDI-X port
1	TD+(transmit)	RD+(receive)
2	TD-(transmit)	RD-(receive)
3	RD+(receive)	TD+(transmit)
4	Not used	Not used
5	Not used	Not used
6	RD-(receive)	TD-(transmit)
7	Not used	Not used
8	Not used	Not used

1000Base-T MDI/MDI-X		
Pin Number	MDI port	MDI-X port
1	BI_DA+	BI_DB+
2	BI_DA-	BI_DB-
3	BI_DB+	BI_DA+
4	BI_DC+	BI_DD+
5	BI_DC-	BI_DD-
6	BI_DB-	BI_DA-
7	BI_DD+	BI_DC+
8	BI_DD-	BI_DC-

Note: "+" and "-" signs represent the polarity of the wires that make up each wire pair.

## Console Port Pin Definition

To connect the console port to an external management device, you need an RJ-45 to DB-9 cable, which is also supplied in the package. Below is the console port pin assignment information.

PC (male) pin assignment	RS-232 with DB9 (female) pin assignment (RJ45-DB9 cable)	RJ45 pin assignment
PIN#2 Rx/D	PIN#2 Rx/D	PIN#2 Rx/D
PIN#3 Tx/D	PIN#3 Tx/D	PIN#3 Tx/D
PIN#5 GND	PIN#5 GND	PIN#5 GND

## Wiring

## Power inputs

The switch supports dual redundant power supplies, Power Supply 1 (PWR1) and Power Supply 2 (PWR2). The connections for PWR1, PWR2 and the RELAY are located on the terminal block.

**STEP 1:** Insert the negative/positive wires into the V-/V+ terminals, respectively.

**STEP 2:** To keep the DC wires from pulling loose, use a small flat-blade screwdriver to tighten the wire-clamp screws on the front of the terminal block connector.

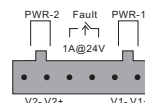

## Relay contact

The two sets of relay contacts of the 6-pin terminal block connector are used to detect user-configured events. The two wires attached to the fault contacts form an open circuit when a user-configured when an event is triggered. If a user-configured event does not occur, the fault circuit remains closed.

## Grounding

Grounding and wire routing help limit the effects of noise due to electromagnetic interference (EMI). Run the ground connection from the ground screws to the grounding surface prior to connecting devices.

## Configurations

After installing the switch, the green power LED should turn on. Please refer to the following tablet for LED indication.

LED	Color	Status	Description
PWR	Green	On	DC power on
PWR1	Green	On	DC power module 1 activated
PWR2	Green	On	DC power module 2 activated
R.M	Green	On	Ring Master
Ring	Green	On	Ring enabled
		Blinking	Ring structure is broken (i.e. part of the ring is disconnected)
Fault	Amber	On	Faulty relay (power failure or port disconnected)
PoE	Green	On	Power supplied over Ethernet
10/100/1000Base-T(X) Gigabit Ethernet ports			
LNK/ACT	Green	On	Port link up
		Blinking	Data transmitted
Speed	Green	On	Port link at 1000Mbps
		Amber	Port link at 10/100Mbps
		Green/Amber	Port link at 10Mbps
10/100/1000Base-T(X) Gigabit PoE Ethernet ports			
LNK/ACT with speed	Green	On	Port link at 1000Mbps
		Blinking	Data transmitted
LNK/ACT	Amber	On	Port link at 10/100Mbps
		Blinking	Data transmitted
SFP			
LNK/ACT	Green	On	Port link up
		Blinking	Data transmitted

Follow the steps to set up the switch:

1. Launch the Internet Explorer and type in IP address of the switch. The default static IP address is **192.168.10.1**

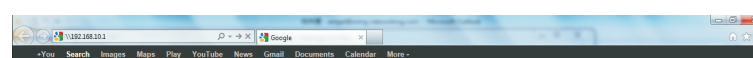

2. Log in with default user name and password (both are **admin**). After logging in, you should see the following screen. For more information on configurations, please refer to the user manual. For information on operating the switch using ORing's Open-Vision management utility, please go to ORing website.



## Resetting

To reboot the switch, press the **Reset** button for 2-3 seconds.

To restore the switch configurations back to the factory defaults, press the **Reset** button for 5 seconds.

## Specifications

ORing Switch Model	IGPS-9842GTP	IGPS-9842GTP-24V
Physical Ports	8 (P.S.E. with IEEE 802.3at)	
10/100/1000Base-T(X) with P.S.E. Ports in RJ45 Auto MDI/MDIX		

10/100/1000Base-T(X) Ports in RJ45 Auto MDI/MDIX	4	
100/1000Base-X with SFP port	2	
<b>Technology</b>		
Ethernet Standards	IEEE 802.3 for 10Base-T IEEE 802.3u for 100Base-TX and 100Base-FX IEEE 802.3z for 1000Base-X IEEE 802.3ab for 1000Base-T IEEE 802.3ad for LACP (Link Aggregation Control Protocol) IEEE 802.3x for Flow control IEEE 802.1p for COS (Class of service) IEEE 802.1Q for VLAN Tagging IEEE 802.1w for RSTP (Rapid Spanning Tree Protocol) IEEE 802.1s for MSTP (Multiple Spanning Tree Protocol) IEEE 802.1x for Authentication IEEE 802.1AB for LLDP (Link Layer Discovery Protocol) IEEE 802.3at PoE specification (up to 30 Watts per port for P.S.E.) 12~24 VDC: total power budget is 60watts with maximum 30watts per port 24~57 VDC: total power budget is 120watts with maximum 30watts per port	
MAC Table	8K	
Priority Queues	8	
Processing	Store-and-Forward	
Switch Properties	Switch latency: 7 us Switch bandwidth: 28Gbps Max. Number of Available VLANs: 256 IGMP multicast groups: 128 for each VLAN Port rate limiting: User Define	
Jumbo frame	Up to 9.6K Bytes	
Security Features	Device Binding security feature Enable/disable ports, MAC based port security Port based network access control (802.1x) VLAN (802.1q) to segregate and secure network traffic Radius centralized password management SNMPv3 encrypted authentication and access security Https / SSH enhance network security	
Software Features	STP/RSTP/MSTP (IEEE 802.1D/w/s) Redundant Ring (O-Ring) with recovery time less than 10ms over 250 units TOS/DiffServ supported Quality of Service (802.1p) for real-time traffic VLAN (802.1Q) with VLAN tagging and GVRP supported IGMP Snooping for multicast filtering IP-based bandwidth management Application-based QoS management DOS/DDOS auto prevention Port configuration, status, statistics, monitoring, security DHCP Server / Client support SMTP Client Modbus TCP	
Network Redundancy	O-Ring, Open-Ring, O-chain, MRP, MSTP (RSTP/STP compatible)	
RS-232 Serial Console Port	RS-232 in RJ45 connector with console cable. Baud rate setting: 115200bps, 8, N, 1	
<b>Power</b>		
Redundant Input power	Dual DC inputs. 50-57VDC on 6-pin terminal block	Dual DC inputs. 12-57VDC on 6-pin terminal block
PoE Power Output	50 ~ 57VDC : total power budget is 240Watts with maximum 30Watts per port	12 ~ 24VDC : total power budget is 60Watts with maximum 30Watts per port 24 ~ 57VDC : total power budget is 120Watts with maximum 30Watts per port
Power consumption(Typ.)	13.2Watts	
Overload current protection	Present	
Reverse polarity protection	Not Present	
<b>Physical Characteristic</b>		
Enclosure	IP-30	
Dimension (W x D x H)	74.3 (W) x 109.2(D) x 153.6(H) mm (2.93 x 4.3 x 6.05 inch)	
Weight (g)	1270 g	
<b>Environmental</b>		
Storage Temperature	-40 to 85°C (-40 to 185°F)	
Operating Temperature	-40 to 70°C (-40 to 158°F)	
Operating Humidity	5% to 95% Non-condensing	
<b>Regulatory Approvals</b>		
EMI	FCC Part 15, CISPR (EN55022) class A	
EMS	EN61000-4-2 (ESD), EN61000-4-3 (RS), EN61000-4-4 (EFT), EN61000-4-5 (Surge), EN61000-4-6 (CS), EN61000-4-11	
Shock	IEC60068-2-27	
Free Fall	IEC60068-2-32	
Vibration	IEC60068-2-6	
Safety	EN60950-1	
Warranty	5 years	

ORing

Copyright © 2014 ORing  
All rights reserved.

ORing Industrial Networking Corp.  
TEL: +886-2-2218-1066 Website: www.oring-networking.com  
FAX: +886-2-2218-1014 E-mail: support@oring-networking.com