

PC-HELPER

High-Resolution Analog Input
Terminal for USB2.0

AI-1608AY-USB

User's Guide

CONTEC CO.,LTD.

Check Your Package

Thank you for purchasing the CONTEC product.

The product consists of the items listed below.

Check, with the following list, that your package is complete. If you discover damaged or missing items, contact your retailer.

Product Configuration List

- USB terminal [AI-1608AY-USB]...1
- Interface connector plugs...2
- First step guide...1
- CD-ROM *1 [API-USBP(WDM)]...1
- USB Cable(1.8m)...1
- USB Cable Attachment...1

*1 The CD-ROM contains the driver software and User's Guide (this guide)

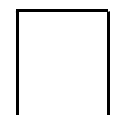
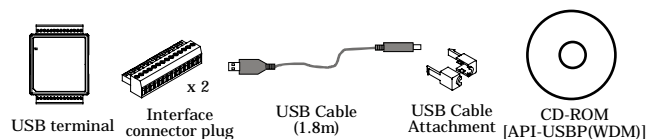

First step guide

Copyright

Copyright 2006 CONTEC CO., LTD. ALL RIGHTS RESERVED.

No part of this document may be copied or reproduced in any form by any means without prior written consent of CONTEC CO., LTD.

CONTEC CO., LTD. makes no commitment to update or keep current the information contained in this document. The information in this document is subject to change without notice.

All relevant issues have been considered in the preparation of this document. Should you notice an omission or any questionable item in this document, please feel free to notify CONTEC CO., LTD.

Regardless of the foregoing statement, CONTEC assumes no responsibility for any errors that may appear in this document or for results obtained by the user as a result of using this product.

Trademarks

MS, Microsoft, Windows and Windows NT are trademarks of Microsoft Corporation. Other brand and product names are trademarks of their respective holder.

Table of Contents

Check Your Package.....	i
Copyright	ii
Trademarks	ii
Table of Contents.....	iii

1. BEFORE USING THE PRODUCT	1
------------------------------------	----------

About the Product	1
Features	1
Support Software	2
Cable & Connector (Option)	3
Customer Support	4
Web Site.....	4
Limited Three-Years Warranty	4
How to Obtain Service	4
Liability.....	4
Safety Precautions	5
Safety Information	5
Handling Precautions.....	5
Environment.....	6
Inspection.....	6
Storage	6
Disposal	6

2. SETUP	7
-----------------	----------

What is Setup?	7
Installing the driver.....	7
Step 1 Setting the Hardware	8
Name of each parts	8
Step 2 Installing the Hardware	9
Connecting the Product.....	9
Setting with the Add New Hardware Wizard.....	10
Setting Properties Using Device Manager	11
Step 3 Initializing the Software	13
Illustration of Menu Screen	13
Installation of API-USBP(WDM) Development Environment.....	14
Installing C-LOGGER	15
Step 4 Checking Operations with the Diagnosis Program	16
What is the Diagnosis Program?	16
Check Method.....	16

Using the Diagnosis Program	17
-----------------------------------	----

3. EXTERNAL CONNECTION	21
-------------------------------	-----------

Using the On-terminal Connectors	21
Connecting a terminal to a Connector	21
Connector Pin Assignment	22
Cable connection.....	23
Analog Signal Connection.....	24
Single-ended Input	24
Digital I/O signals Connection	25

4. APPLICATION DEVELOPMENT	27
-----------------------------------	-----------

Reference to Online Help	27
Printing Function Reference	27
Sample Program.....	28
Distributing Developed Application.....	28
Use of utility program.....	29
Returning to Initial State.....	32

5. ABOUT C-LOGGER	33
--------------------------	-----------

6. FUNCTIONS	35
---------------------	-----------

Analog Input Function	35
1. Setting the Conversion Conditions	36
2. Starting/Stopping Operation	42
3. Monitoring the Status and Acquiring Data.....	42
4.Reset.....	45
Digital Input Function.....	46
Digital Output Function	47

7. ABOUT HARDWARE	49
--------------------------	-----------

Hardware specification	49
External dimensions.....	50
Block Diagram.....	51
Control Signal Timings.....	52
Control Signal Timings for Analog Input	52
About Calibration	53

1. Before Using the Product

About the Product

This product is a USB2.0-compatible analog input terminal, which can be connected to a USB interface of a PC to perform analog measurements easily.

Each product accepts the analog input (16bit, 8ch), digital input (LVTTTL x 4), digital output (LVTTTL x 4).

Using the bundled driver library [API-USBP(WDM)], you can create Windows application software for this converter in your favorite programming language supporting Win32 API functions, such as Visual Basic or Visual C++. It can also collect data easily without a program when the attached data logger software [C-LOGGER] is used.

Features

- Analog inputs (16-bit, 8 channels), digital inputs (x 4) and digital outputs (x 4) are available.
- Compliant with USB2.0/USB1.1 specifications and capable of a high-speed transfer (480Mbps)
- Powered by the bus, enabling operation without an external power supply.
- Analog input can be synchronized with an external signal.
- Equipped with the buffer memory (1k Word) that can be used as FIFO or RING format
- All adjustment to analog inputs can be performed by software.
Troublesome jumper setup is not required. Adjustment information other than the default information can be saved so that the adjustment information that is suitable for the use environment is available.
- Easy-to-wire screw-type connector adopted
- Supporting the data logger software [C-LOGGER] that enables the graph display of recorded signal data, file saving, and dynamic transfer to the spreadsheet software program "Excel"

Support Software

You should use CONTEC support software according to your purpose and development environment.

Driver Library **API-USBP(WDM)** (Bundled)

It is the library software, and which supplies command of hardware produced by our company in the form of standard Win32 API function(DLL). Using programming languages supporting Win32API functions, such as Visual Basic and Visual C++ etc., you can develop high-speed application software with feature of hardware produced by our company.

In addition, you can verify the operation of hardware using Diagnostic programs.

CONTEC provides download services (at <http://www.contec.com/apiusbp/>) to supply the updated drivers and differential files.

Further details may be found in the help within supplied CD-ROM or the homepage of our company.

< Operating Environment >

OS	Windows XP, Server 2003, 2000, Me, 98, etc..
Adaptation language	Visual C++ .NET, Visual C# .NET, Visual Basic .NET, Visual C++, Visual Basic, Delphi, C++Builder, etc..

Data Logger Software **C-LOGGER** (Supplied: Stored on the API-USBP(WDM) CD-ROM)

C-LOGGER is a data logger software program compatible with our analog I/O products. This program enables the graph display of recorded signal data, zoom observation, file saving, and dynamic transfer to the spreadsheet software "Excel". No troublesome programming is required.

CONTEC provides download services (at <http://www.contec.co.jp/clogger>) to supply the updated drivers.

For details, refer to the C-LOGGER Users Guide or our website.

< Operating Environment >

OS	Windows XP, Server 2003, 2000
----	-------------------------------

Data acquisition VI library for LabVIEW **VI-DAQ** (Available for downloading (free of charge) from the CONTEC web site.)

This is a VI library to use in National Instruments LabVIEW.

VI-DAQ is created with a function form similar to that of LabVIEW's Data Acquisition VI, allowing you to use various devices without complicated settings.

See <http://www.contec.com/vidaq/> for details and download of VI-DAQ.

Data Acquisition library for MATLAB **ML-DAQ** (Available for downloading (free of charge) from the CONTEC web site.)

This is the library software which allows you to use our analog I/O device products on MATLAB by the MathWorks. Each function is offered in accordance with the interface which is integrated in MATLAB's Data Acquisition Toolbox.

See <http://www.contec.com/mldaq/> for details and download of ML-DAQ.

Cable & Connector (Option)

14pin Screw Terminal Connector Set(6 pieces) : CN6-Y14

* Check the CONTEC's Web site for more information on these options.

Customer Support

CONTEC provides the following support services for you to use CONTEC products more efficiently and comfortably.

Web Site

Japanese <http://www.contec.co.jp/>
English <http://www.contec.com/>
Chinese <http://www.contec.com.cn/>

Latest product information

CONTEC provides up-to-date information on products.

CONTEC also provides product manuals and various technical documents in the PDF.

Free download

You can download updated driver software and differential files as well as sample programs available in several languages.

Note! For product information

Contact your retailer if you have any technical question about a CONTEC product or need its price, delivery time, or estimate information.

Limited Three-Years Warranty

CONTEC product are warranted by CONTEC CO., LTD. to be free from defects in material and workmanship for up to three years from the date of purchase by the original purchaser.

Repair will be free of charge only when this device is returned freight prepaid with a copy of the original invoice and a Return Merchandise Authorization to the distributor or the CONTEC group office, from which it was purchased.

This warranty is not applicable for scratches or normal wear, but only for the electronic circuitry and original products. The warranty is not applicable if the device has been tampered with or damaged through abuse, mistreatment, neglect, or unreasonable use, or if the original invoice is not included, in which case repairs will be considered beyond the warranty policy.

How to Obtain Service

For replacement or repair, return the device freight prepaid, with a copy of the original invoice. Please obtain a Return Merchandise Authorization Number (RMA) from the CONTEC group office where you purchased before returning any product.

* No product will be accepted by CONTEC group without the RMA number.

Liability



The obligation of the warrantor is solely to repair or replace the product. In no event will the warrantor be liable for any incidental or consequential damages due to such defect or consequences that arise from inexperienced usage, misuse, or malfunction of this device.

Safety Precautions

Understand the following definitions and precautions to use the product safely.

Safety Information

This document provides safety information using the following symbols to prevent accidents resulting in injury or death and the destruction of equipment and resources. Understand the meanings of these labels to operate the equipment safely.

 DANGER	DANGER indicates an imminently hazardous situation which, if not avoided, will result in death or serious injury.
 WARNING	WARNING indicates a potentially hazardous situation which, if not avoided, could result in death or serious injury.
 CAUTION	CAUTION indicates a potentially hazardous situation which, if not avoided, may result in minor or moderate injury or in property damage.

Handling Precautions

DANGER

Do not use the product where it is exposed to flammable or corrosive gas. Doing so may result in an explosion, fire, electric shock, or failure.

CAUTION

- Do not strike or bend the converter.
Otherwise, the converter may malfunction, overheat, cause a failure or breakage.
- Do not touch the converter's pin parts (USB connector) with your hands.
Otherwise, the converter may malfunction, overheat, or cause a failure.
If the pin parts are touched by someone's hands, clean the parts with industrial alcohol.
- Do not touch the external connector (14 pin plug header) when the power is on.
Otherwise this may malfunction, overheat, cause a failure due to static electricity.
- Make sure that your PC or expansion unit can supply ample power to all the products installed.
Insufficiently energized products could malfunction, overheat, or cause a failure.
- The specifications of this product are subject to change without notice for enhancement and quality improvement.
Even when using the product continuously, be sure to read the manual and understand the contents.
- Do not modify the product. CONTEC will bear no responsibility for any problems, etc., resulting from modifying this product.
- Regardless of the foregoing statements, CONTEC is not liable for any damages whatsoever (including damages for loss of business profits) arising out of the use or inability to use this CONTEC product or the information contained herein.

Environment

Use this product in the following environment. If used in an unauthorized environment, the converter may overheat, malfunction, or cause a failure.

Operating temperature

0 - 50°C

Humidity

10 - 90%RH (No condensation)

Corrosive gases

None

Floating dust particles

Not to be excessive

Inspection

Inspect the product periodically as follows to use it safely.

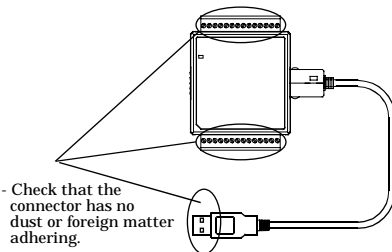

- Check that the connector has no dust or foreign matter adhering.

Storage

When storing this product, keep it in its original packing form.

- (1) Put the product in the storage bag.
- (2) Wrap it in the packing material, then put it in the box.
- (3) Store the package at room temperature at a place free from direct sunlight, moisture, shock, vibration, magnetism, and static electricity.

Disposal

When disposing of the product, follow the disposal procedures stipulated under the relevant laws and municipal ordinances.

2. Setup

This chapter explains how to set up the product.

What is Setup?

Setup means a series of steps to take before the product can be used.

Different steps are required for software and hardware.

Installing the driver

This section enables you to prepare the software and hardware by operating in accordance with each step in this chapter using the bundled CD-ROM. Taking the following steps sets up the software and hardware. You can use the diagnosis program later to check whether the software and hardware function normally.

Step 1 Setting the Hardware

Step 2 Installing the Hardware

Step 3 Installing the Software

Step 4 Checking Operations with the Diagnosis Program

Uninstall the driver and then set it up again if it cannot be set up properly.

Step 1 Setting the Hardware

This section describes how to set up the product and how to connect it to a PC.

Name of each parts

LED indicator

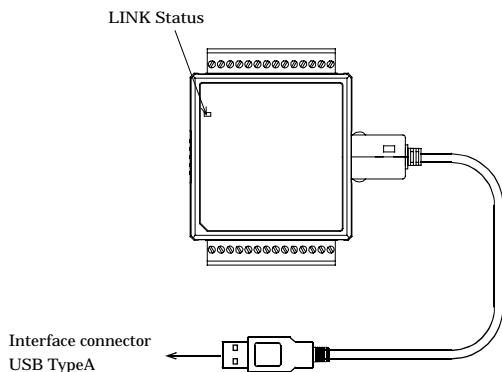

Figure 2.1. Name of each parts (Front side)

Table 2.1. List of Status LED Functions

Name	Function	Indicator color	LED indicator
LINK Status	USB communication status	GREEN	ON : Communication established
			OFF : Communication unestablished
	PC connection status		ON : PC communication established
			OFF : PC communication unestablished

Step 2 Installing the Hardware

Under Windows, information about the converter needs to be detected by the OS. This is called hardware installation.

To use more than one of this product, make sure to install them one by one, setting each unit after completing the previous one.

The following shows the basic flow for installing product.

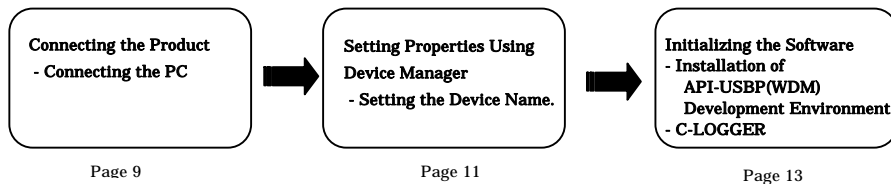

Connecting the Product

- (1) Turn on the power to the PC before connecting the product.
- (2) When the PC has been up and running, plug the USB interface connector to a USB port in the PC. The converter can also be connected to the PC via a USB hub.

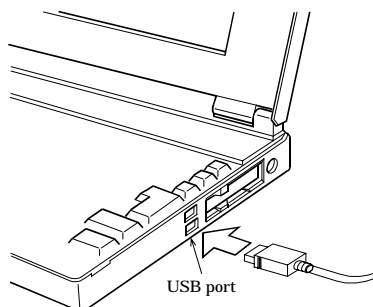

Figure 2.2. Connecting the PC

- (3) USB cable can be attached firmly to the main unit by using a USB cable attachment.

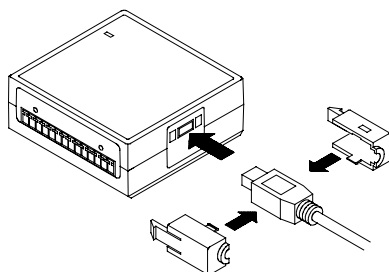

Figure 2.3. Attaching a USB Attachment

⚠ CAUTION

The USB cable attachment cannot be used excluding an attached cable.

Setting with the Add New Hardware Wizard

- (1) The “Found New Hardware Wizard” will be started.
- (2) Select “Install from a list or specific location”, then click on the [Next] button.
Detect setup information from supplied CD automatically for installing USB driver.



Point

Please specify the path for supplied CD as follows in the case of failure in detecting automatically.
X:\INF\WDM\AIO (X: CD-ROM drive)

- (3) Click on [Finish] button to complete the installation of USB driver.



Setting Properties Using Device Manager

After connecting product with a PC and completing driver installation, open Device Manager and set properties.

(1) Starting Device Manager.

From [Start] menu, click on [Settings]-[Control Panel]-[System] and then click on [Device Manager] button in [Hardware] tab.

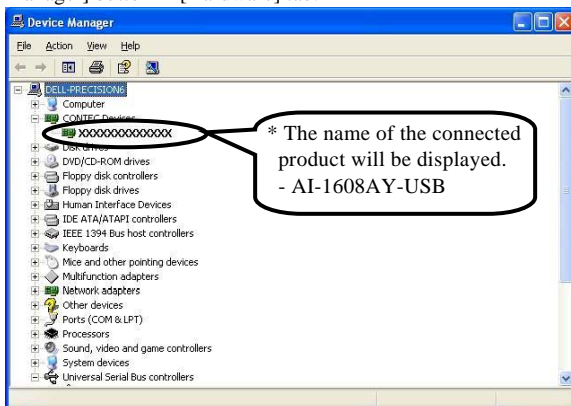

- In the case of Windows 98

Right-click on [My Computer] and select [Properties] to start device manager.

(2) Setting the Device Name.

Right-clicking on the product name and selecting [Properties] displays [Product Properties].

Open [Common Settings] tab and enter arbitrary name in the editing box for device name. (Default name also can be used.)

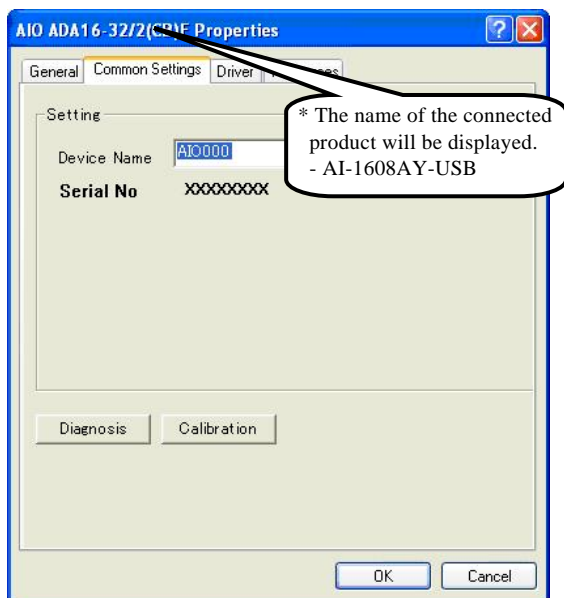

* The product-specific number will be displayed as the serial number.

⚠ CAUTION

USB driver can not be used without settings. Settings must be performed.

(3) Clicking on [OK] button.

Device name is set by clicking [OK] button.

Step 3 Initializing the Software

Connect with the product, and install following software if USB driver has been installed. The following description assumes the operating system as Windows XP. Although some user interfaces are different depending on the OS used, the basic procedure is the same.

Points

- If you are using Windows XP or Windows 2000, please log on as Administrator (authorized account) before proceeding to the following steps.

Illustration of Menu Screen

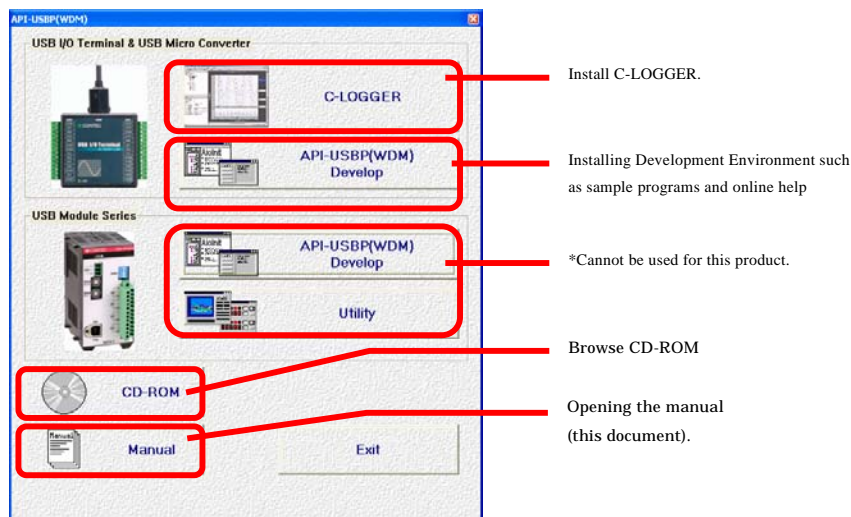

Points

- Please set up the supplied CD-ROM if it has not been set up. The menu starts automatically.
- If the menu do not start, launch X:AUTORUN.EXE(X:CD-ROM drive) from [Run...] in Start menu.
- The screen design may be different.

Installation of API-USBP(WDM) Development Environment

Installation of development environment is namely installing supplied online help and sample program in all language in order to use API function.

- (1) Clicking on “API-USBP(WDM) Develop”.

[Installing the development environment] dialog box displays.

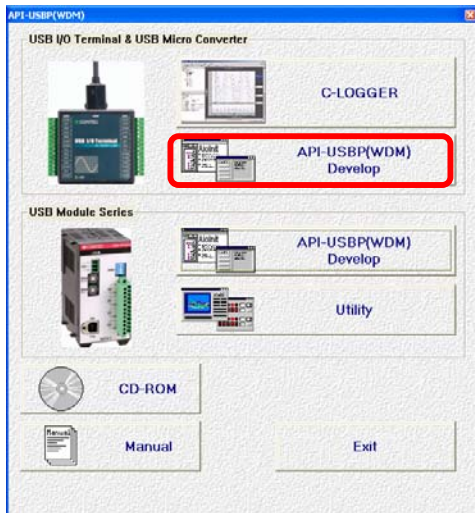

- (2) Selecting “Analog I/O Development”.

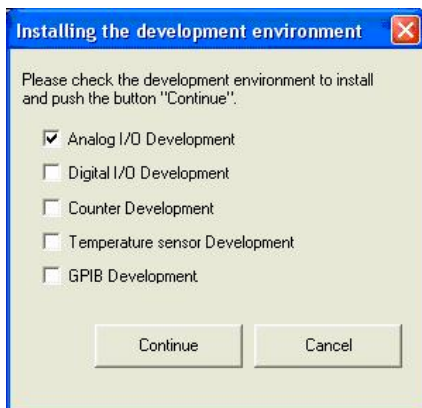

- (3) Clicking on “Continue” Button.

Please perform installation following the directions on the screen. And thus the installation is completed.

* The screen design may be different.

Installing C-LOGGER

Install the data collection software.

- (1) Clicking on “C-LOGGER”.

[Choose Setup Language] dialog box displays.

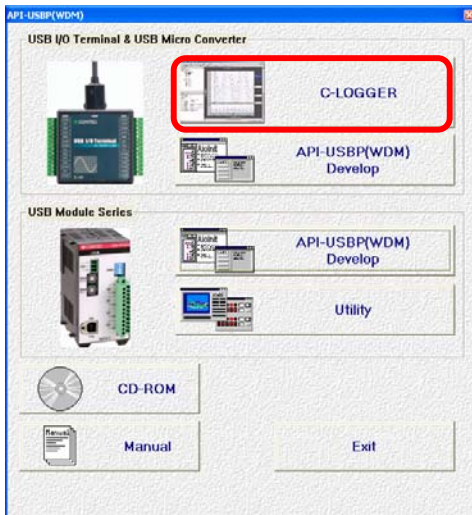

- (2) Selecting “English”.

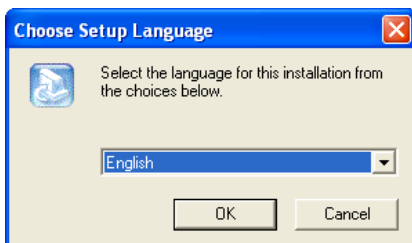

- (3) Clicking on “OK” Button.

Please perform installation following the directions on the screen. And thus the installation is completed.

- * The screen design may be different.

Step 4 Checking Operations with the Diagnosis Program

Use the diagnosis program to check that the product and driver software work normally, thereby you can confirm that they have been set up correctly.

What is the Diagnosis Program?

The diagnosis program diagnoses the states of the product and driver software.

It can also be used as a simple checker when an external device is actually connected.

Using the “Diagnosis Report” feature reports the driver settings, the presence or absence of the product, I/O status, and interrupt status.

Check Method

To check the analog I/O data, connect to an external signal source.

The figure below shows an example of checking by connecting to an external signal.

The analog input example illustrated below is an example of using analog input channel 0.

Connection diagram

< Analog Input >

- Single-Ended Input

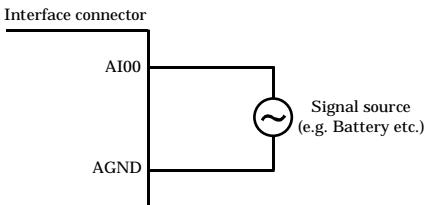

CAUTION

Input data remains indeterminate when no input pin is connected. The input pin for the channel not connected to the signal source must be connected to the analog ground.

For details, see “Chapter 3 External Connection”.

Using the Diagnosis Program

Starting the Diagnosis Program

Click [Diagnosis] on the Properties page to start the diagnosis program.

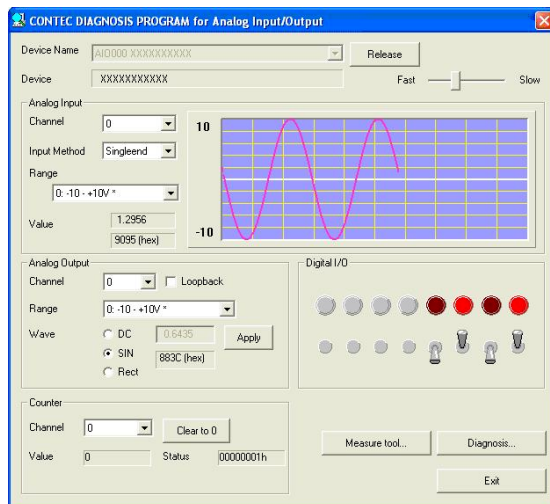
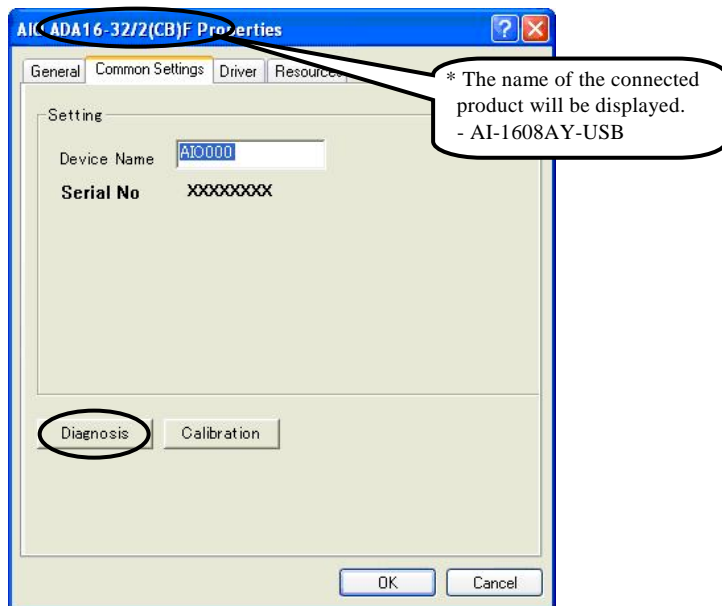

* You cannot use the counter function with this product.

Analog input

Select the input channel and input type from the lists.

Input data is plotted on a graph.

Digital I/O

The upper row of circular lamps indicates the digital input states. Red indicates the bit is ON and brown indicates OFF.

Clicking the lower row of switches turns the digital output bits ON or OFF.

Diagnosis Report

- (1) The diagnosis report saves detailed data, including the device settings and settings for each channel, to a text file and displays the file for you to view.

Clicking [Diagnosis Report] prompts you to specify where to save the report text file.

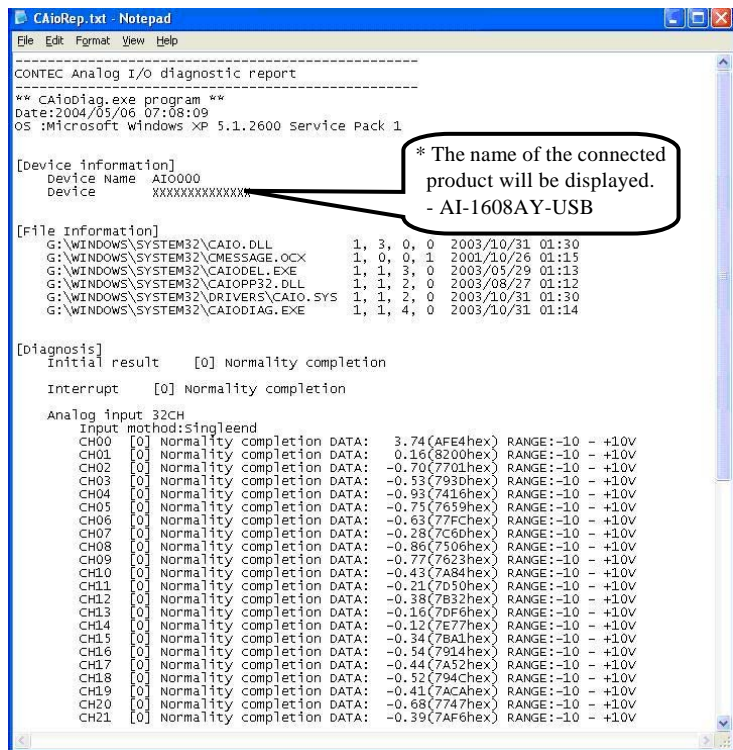

```

CAioRep.txt - Notepad
File Edit Format View Help
-----
CONTEC Analog I/O diagnostic report
-----
** CAioDiag.exe program **
Date:2004/05/06 07:08:09
OS :Microsoft windows XP 5.1.2600 Service Pack 1

[Device Information]
Device Name AI0000
Device      XXXXXXXXXXXXXXXX

[File Information]
G:\WINDOWS\SYSTEM32\CAIO.DLL          1, 3, 0, 0 2003/10/31 01:30
G:\WINDOWS\SYSTEM32\CMESSAGE.OCX     1, 0, 0, 1 2001/10/26 01:15
G:\WINDOWS\SYSTEM32\CAIODEL.EXE      1, 1, 3, 0 2003/05/29 01:13
G:\WINDOWS\SYSTEM32\CAIOPP32.DLL     1, 1, 2, 0 2003/08/27 01:12
G:\WINDOWS\SYSTEM32\DRIVERS\CAIO.SYS 1, 1, 2, 0 2003/10/31 01:30
G:\WINDOWS\SYSTEM32\CAIODIAG.EXE     1, 1, 4, 0 2003/10/31 01:14

[Diagnosis]
Initial result [0] Normality completion
Interrupt [0] Normality completion

Analog input 32CH
Input method:Singleend
CH00 [0] Normality completion DATA: 3.74(AFE4hex) RANGE:-10 - +10V
CH01 [0] Normality completion DATA: 0.16(8200hex) RANGE:-10 - +10V
CH02 [0] Normality completion DATA: -0.70(770Lhex) RANGE:-10 - +10V
CH03 [0] Normality completion DATA: -0.53(793Dhex) RANGE:-10 - +10V
CH04 [0] Normality completion DATA: -0.93(7416hex) RANGE:-10 - +10V
CH05 [0] Normality completion DATA: -0.75(7659hex) RANGE:-10 - +10V
CH06 [0] Normality completion DATA: -0.63(77FChex) RANGE:-10 - +10V
CH07 [0] Normality completion DATA: -0.28(7C6Dhex) RANGE:-10 - +10V
CH08 [0] Normality completion DATA: -0.86(7506hex) RANGE:-10 - +10V
CH09 [0] Normality completion DATA: -0.77(7623hex) RANGE:-10 - +10V
CH10 [0] Normality completion DATA: -0.43(7A84hex) RANGE:-10 - +10V
CH11 [0] Normality completion DATA: -0.21(7D50hex) RANGE:-10 - +10V
CH12 [0] Normality completion DATA: -0.38(7B32hex) RANGE:-10 - +10V
CH13 [0] Normality completion DATA: -0.16(7DF6hex) RANGE:-10 - +10V
CH14 [0] Normality completion DATA: -0.12(7E77hex) RANGE:-10 - +10V
CH15 [0] Normality completion DATA: -0.34(7BA1hex) RANGE:-10 - +10V
CH16 [0] Normality completion DATA: -0.54(7914hex) RANGE:-10 - +10V
CH17 [0] Normality completion DATA: -0.44(7A52hex) RANGE:-10 - +10V
CH18 [0] Normality completion DATA: -0.52(794Chex) RANGE:-10 - +10V
CH19 [0] Normality completion DATA: -0.41(7ACAhex) RANGE:-10 - +10V
CH20 [0] Normality completion DATA: -0.68(7747hex) RANGE:-10 - +10V
CH21 [0] Normality completion DATA: -0.39(7AF6hex) RANGE:-10 - +10V
  
```

- (2) The diagnosis report contains the following data.
- Version of OS
 - Device Information
 - File Information
 - Initialization, interrupts, current input or output state for each channel

3. External Connection

This chapter describes the interface connectors on the product.

Check the information available here when connecting an external device.

Using the On-terminal Connectors

Connecting a terminal to a Connector

To connect an external device to this terminal, plug the cable from the device into the interface connector (CN1, CN2) shown below.

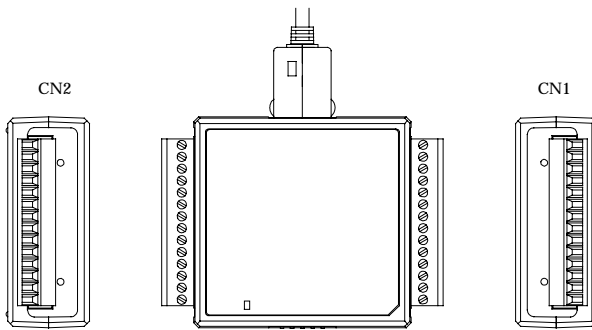

Figure 3.1. Interface Connectors and Mating Connectors

Connector Pin Assignment

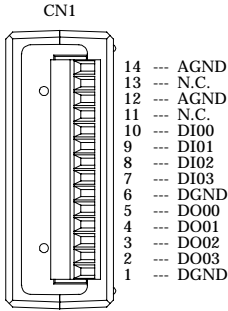

Figure 3.2. Pin Assignment of CN1

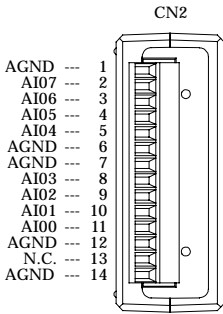

Figure 3.3. Pin Assignment of CN2

Table 3.1. Signal name of CN1 and CN2

AI00 - AI07	Analog input signal. The numbers correspond to channel numbers.
AGND	Common analog ground for analog input signals.
DI00 - DI03	Digital input signal.
DO00 - DO03	Digital output signal.
DGND	Common digital ground for digital I/O signals

Cable connection

When connecting the product to an external device, you can use the supplied connector plug.

For wiring, strip off approximately 9 - 10mm of the covered part of a wire rod and then insert it to the opening. After the insertion, secure the wire rod with screws. Compatible wires are AWG 28 - 16.

⚠ CAUTION

Removing the connector plug by grasping the cable can break the wire.

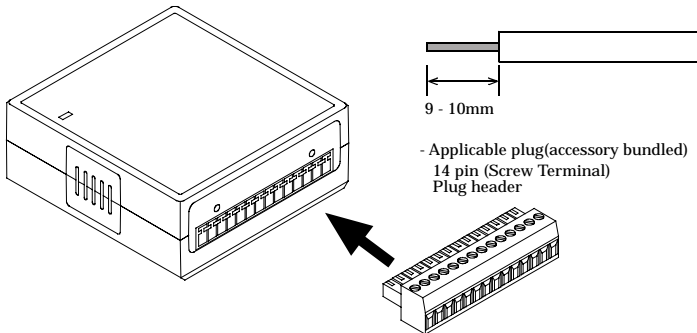

Figure 3.4. Connecting an Interface Connector and Connectors That Can Be Used

Analog Signal Connection

Analog signal input types are divided into single-ended input and differential input. This product uses single-ended input fixed. The following examples show how to connect analog input signals using a flat cable and a shielded cable.

Single-ended Input

The following figure shows an example of flat cable connection.

Connect separate signal and ground wires for each analog input channel on CN1.

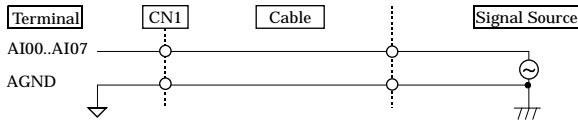

Figure 3.5. Single-ended Input Connection (Flat Cable)

The following figure shows an example of shield cable connection. Use shielded cable if the distance between the signal source and product is long or if you want to provide better protection from noise. For each analog input channel, connect the core wire to the signal line and connect the shielding to ground.

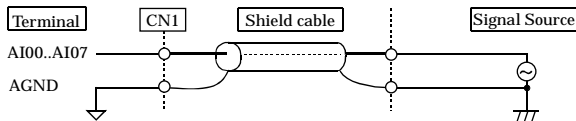

Figure 3.6. Single-ended Input Connection (Flat Cable)

⚠ CAUTION

- If the signal source contains over 1MHz signals, the signal may effect the cross-talk noise between channels.
- If the product and the signal source receive noise or the distance between the product and the signal source is too long, data may not be input properly.
- An input analog signal should not exceed the maximum input voltage (relate to the product analog ground). If it exceeds the maximum voltage, the product may be damaged.
- Connect all the unused analog input channels to analog ground.
- The signal connected to an input channel may fluctuate after switching of the multiplexer. In this case, the cable between this product and the signal source can be shortened or a buffer with a high-speed amplifier can be placed between the product and the signal source in order to reduce the fluctuation.

Digital I/O signals Connection

The digital I/O signal can be used as the control signal (external trigger input signal and sampling clock input signal, etc.), too. The following sections show examples.

All the digital I/O signals are LVTTTL (3.3VDC) level signals.

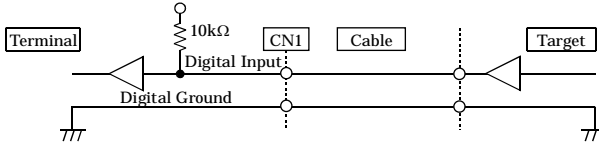

Figure 3.7. Digital Input Connection

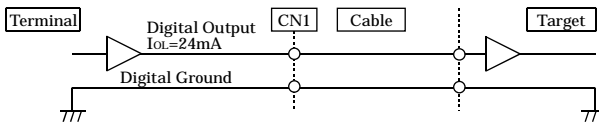

Figure 3.8. Digital Output Connection



CAUTION

Do not short the output signals to analog ground, digital ground, and/or power line. Doing so may damage the terminal.

Each input accepts TTL(5VDC) level signals.

Reference

For the operation timing when using it as control signal, see "Control Signal Timings" in Chapter 7 "About Hardware - Control Signal Timings".



CAUTION

The external trigger signal is fixed to the following signal location when using C-LOGGER.

DI00 : External start trigger signal input

* The external stop tripper and external clock cannot be used.

4. Application Development

Please reference to online help and sample program when developing applications.

Reference to Online Help

Click on [Programs]-[CONTEC API-USBP(WDM)]-[API-USBP(WDM) Help] from [Start] menu.

The information for application development, such as function reference is provided in [API-USBP(WDM) Help].

Detailed introduction to search method for help should be found from [How to navigate Help] in the help.

For basic usage, please reference to “Tutorial” for help.

Printing Function Reference

Clicking on Print button from online help prints the page being displayed. It can be printed entirely as follows in the case of referencing to printing function.

As figure shown on the right, selecting  mark and clicking on Print button prints all the topics under the mark selected at a time.

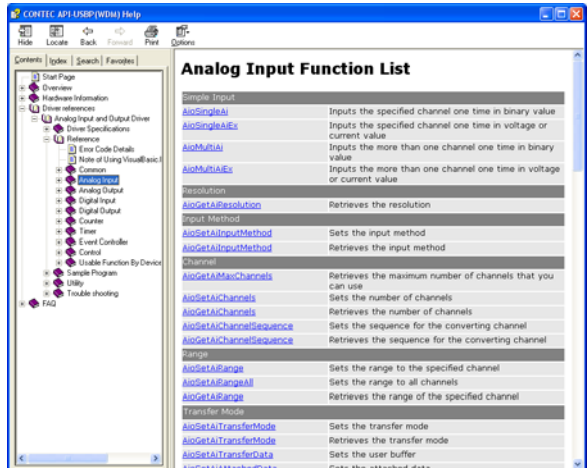

Sample Program

Sample programs are copied in installation path. (The default path is Program Files\CONTEC~)

Sample programs in all language are provided here. To run a sample program, click on [Programs]-[CONTEC API-USBP(WDM)]-[AIO]-[Sample Name] from [Start] menu.

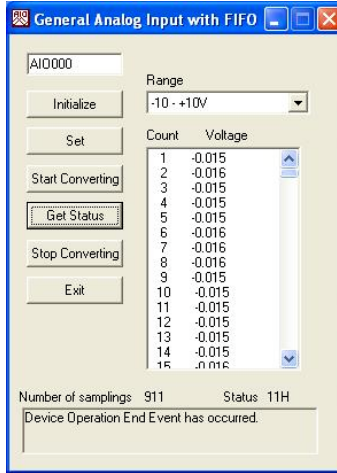

Distributing Developed Application

Please distribute the developed application with USB driver in supplied CD.

Created application (including driver) can be freely distributed.

Use of utility program

Program for Measuring the Executive Speed of Function

Program for measuring the executive speed of function is a program that can measure the executive time of some main functions.

To use the program for measuring the executive speed of function, please click the button "Measure tool..." from CONTEC DIAGNOSIS PROGRAM.

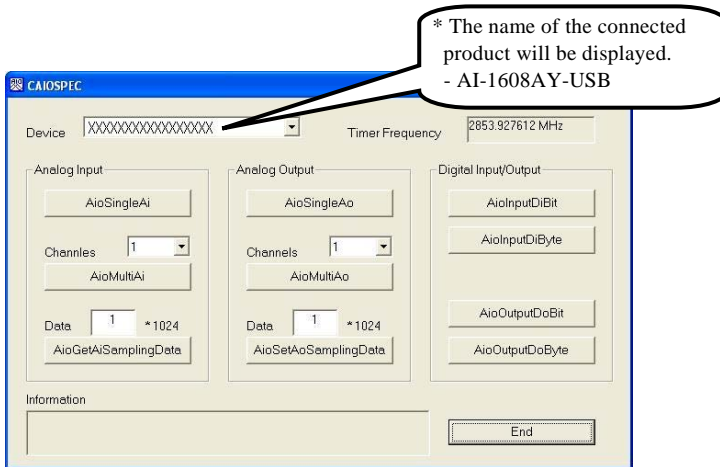

Step to use

- (1) Select the device to be measured from the device list.
- (2) Measure the executive speed of a function by clicking the button with the function name.
Select the number of channels for conversion from the list for AioMultiAi and AioMultiAo.
Input the size of data to be transferred for AioGetAiSamplingData and AioSetAoSamplingData.
Set the transfer data in "kByte".
- (3) Terminate the application by clicking the button "Exit".

Measuring Analog Input tool

This is a utility that measuring Analog input with FIFO memory infinitely. Retrieves the data from memory as the event is occurred because the number of conversion data has arrived at the maximum. The data of FIFO memory is more visual displayed.

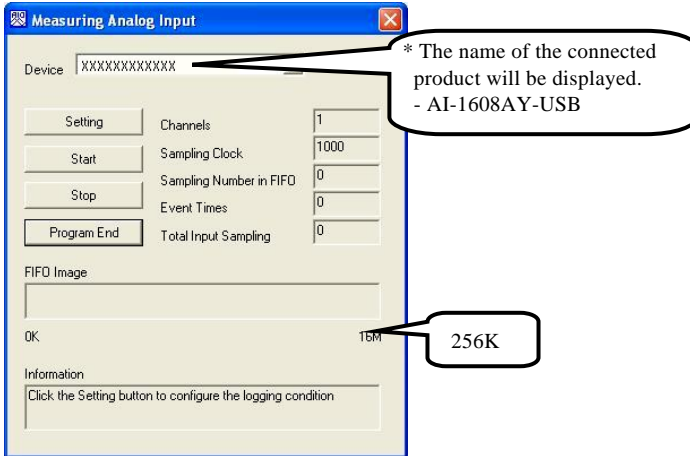

Setting Channels, Internal/External Clock, Sampling Clock, Sampling Number that it makes event occurring. After the sampling clock error event is occurred, setting all of conversion condition.

Step to use

- (1) The device used is selected from the list of the device, and a set button is clicked.
- (2) Setting the conversion condition on the form of [Setting Analog Input].

Retrieves the data from memory as the event is occurred because the number of conversion data has arrived at the specified number. Return to original form, after clicked the button of [OK].

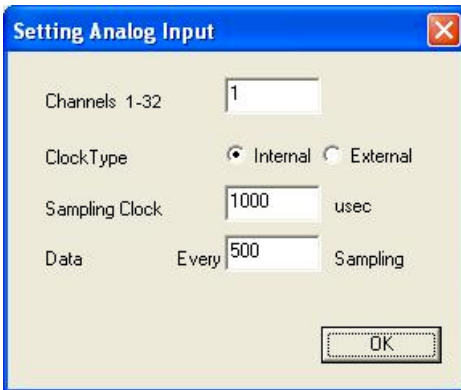

- (3) The measuring is began after clicked the button of [Start], the conversion's information is displayed.

The sampling number within FIFO :

That is the conversion data is stored at memory, That is more visual displayed in [Memory Image].

The sampling number when event :

The event is occurred when the input sampling number within FIFO reach this number.

Total Input Sampling Number :

The total sampling number is stored at memory for this application.

The Measuring will stop when this error as follows.

Sampling clock error :

When the application is measuring with internal clock, sampling clock is too fast to process.

When the application is measuring with External clock, clock cycle is too fast. moreover, noise is be considered.

Buffer overflow :

The memory has overflowed because the conversion speed is too fast compared with the speed at which data is taken.

- (4) The measuring is stopping after clicked the button of [Stop].

Returning to Initial State

This is the method of returning to initial state. It is suggested that you should return to initial state and perform installation again when the operation is losing stabilization.

- (1) Deleting Device form Device Manager.

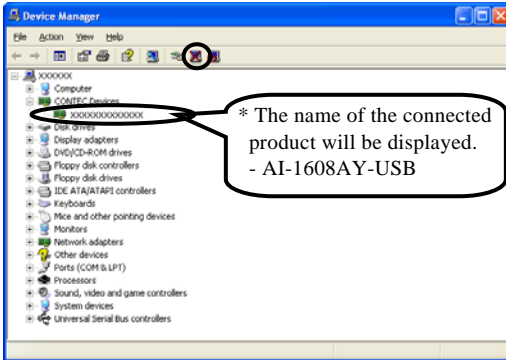

- (2) Drawing USB cable from a PC

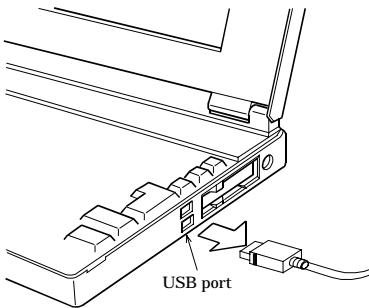

- (3) Uninstalling Driver

Select [CONTEC API-AIO(WDM) driver] from [My Computer]-[Control Panel]-[Add/Remove Programs].

- (4) Restarting

5. About C-LOGGER

C-LOGGER is a data logger software program compatible with our analog I/O products. This program enables the graph display of recorded signal data, zoom observation, file saving, and dynamic transfer to the spreadsheet software “Excel”. No troublesome programming is required.

The program is stored on the attached CD-ROM [Driver Library API-USBP (WDM)].

C-LOGGER offers the following functions.

- Sampling and displaying data with high-speed
- Supporting plural windows
- Sending to excel with high-speed
- Supporting 2 data (binary and csv) forms
- Setting acquirement conditions easily with wizard
- Operating intuitively with file viewer and property viewer
- Saving to file automatically for long-time and mass-data acquirement
- Displaying Graph in 2 Screens: Whole and Zoom
- Abundant Function for Customization

For details, refer to the C-LOGGER Users Guide.

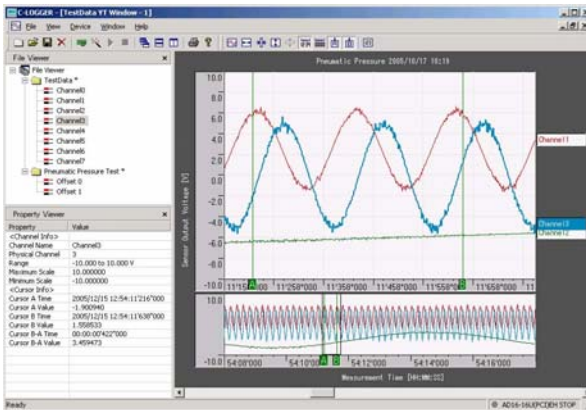

6. Functions

This chapter describes the different functions that can be implemented using the hardware and driver together. Unless stated otherwise, the driver is assumed to be API-USBP(WDM).

*Some of the functions may not be available when the data logger software (C-LOGGER) is in use.

Analog Input Function

The board converts analog signals to digital data according to the resolution and stores it in memory.

You can set a variety of conditions for analog input, including the input channel, sampling period, and sampling start/stop conditions.

Analog input processes are classified as follows:

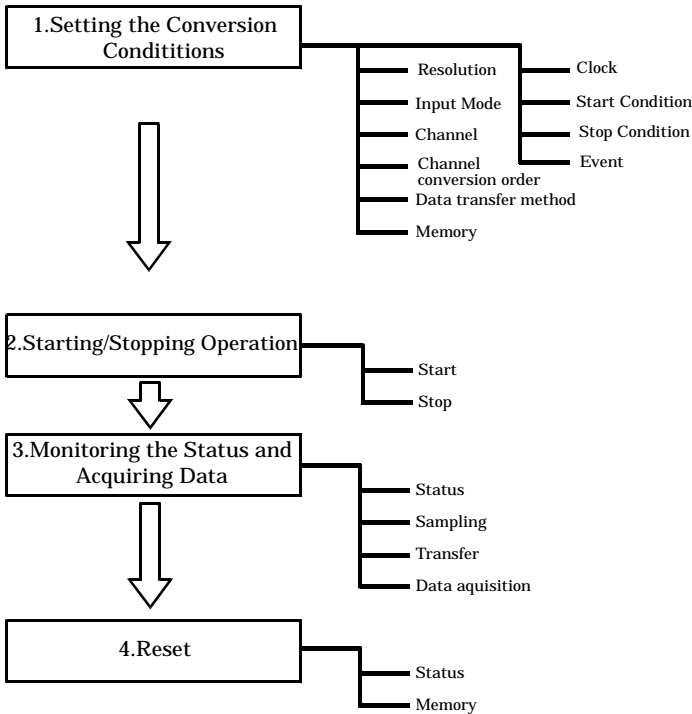

1. Setting the Conversion Conditions

First, set the conditions for executing analog input.

Resolution

"Resolution" signifies the number of bits used by an analog input device to represent analog signals. The higher the resolution, the more finely the voltage range is segmented, allowing the device to convert analog values to digital equivalents more precisely.

A device with a resolution of 12-bit divides the range width into 4096 segments.

When the device covers the range of 0 - 10V, the minimum unit of converted voltages is $10 \div 4096 \approx 2.44\text{mV}$.

If the device has a resolution of 16-bit, it is $10 \div 65536 \approx 0.153\text{mV}$ instead.

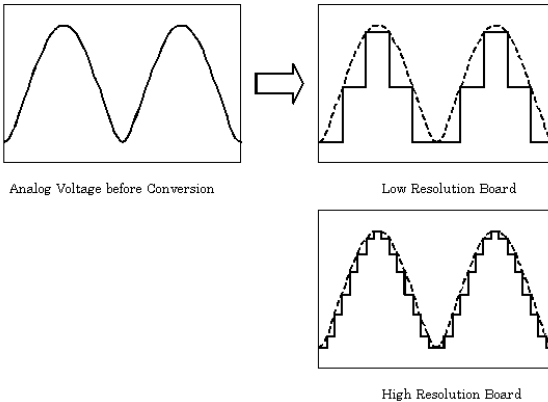

AI-1608AY-USB : The resolution is 16-bit.

Input Mode

"Input Mode" indicates the method of connecting analog input signals.

The input modes available are single-ended input and differential input.

The single-ended input mode is suitable for the environment in which the potential difference between the signal source and ground and noise components can be ignored. For the environment in which they cannot be ignored, the differential input mode is suitable. The number of channels available in differential input mode is half that in single-ended input mode.

Software setup of the input mode is not required as this product uses the single-ended input mode fixed.

Channel

"Channel" represents each point of analog input.

For individual channel numbers, see "Using the On-board Connectors" to "Connector Pin Assignment" in Chapter 3 "External Connection".

You can specify an arbitrary number of points of analog input by setting the channels by means of software.

Channel conversion order

Normally, when performing conversion for more than one channel at each sampling, conversion is performed consecutively starting from channel 0.

Software setup is not required as this product uses a fixed channel conversion priority.

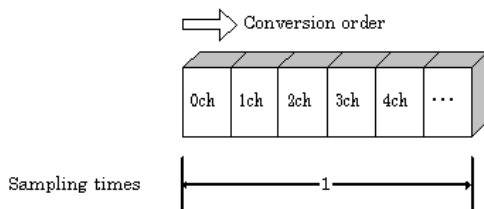

Range

”Range” means the range of voltages at which analog input can be performed.

Software setup of the range is not required as this product uses a fixed range of voltages.

AI-1608AY-USB : $\pm 10V$

Data transfer method

A device buffer mode is available, which uses the device's or driver's conversion data storage memory.

- Device buffer mode

When conversion starts, data is saved in the device buffer (memory on the device itself or in the driver).

The device buffer can operate as FIFO or ring memory.

The application calls an API function at an appropriate timing and fetches the conversion data from the device buffer.

The device buffer mode provides function that allows the number of items of conversion data using the number of sampling times as a unit to obtain the number of items of conversion data directly from the voltage.

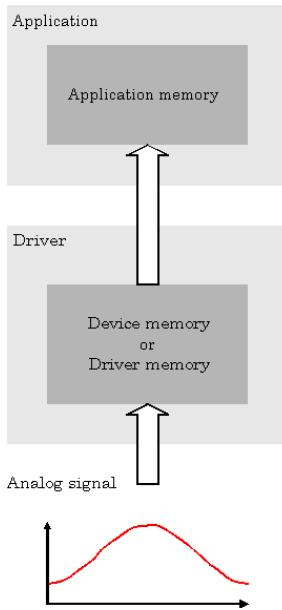

Device buffer mode

Memory format

This product uses device buffer transfer mode; it does not require software setup of the memory format.

Device buffer mode

- FIFO format

In the FIFO (First In First Out) format, input data items are read from memory in the same order in which they were written to the memory. Input data items are fed out of the memory sequentially, where the oldest one is always read from the memory. The status monitor and application notification functions are provided, which check and report the state in which the memory has stored a fixed amount of data or in which the memory has become full.

The FIFO memory is used to obtain all input data from analog input in a short or infinite period of time.

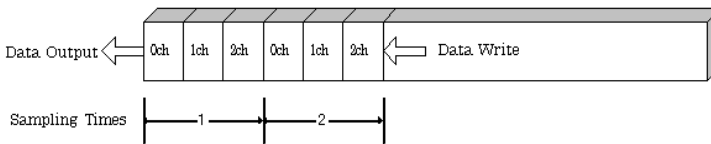

- Ring format

In the ring format, the memory contains storage areas arranged in a ring. Input data items are written to the memory sequentially. When it stores data exceeding the limit, it overwrites the area storing the previous item of input data. The status monitor and application notification functions are provided, which check and report the state in which data has been written to certain areas of memory.

The ring memory is used to obtain data where conversion has stopped due to some event, usually without obtaining data in the normal state.

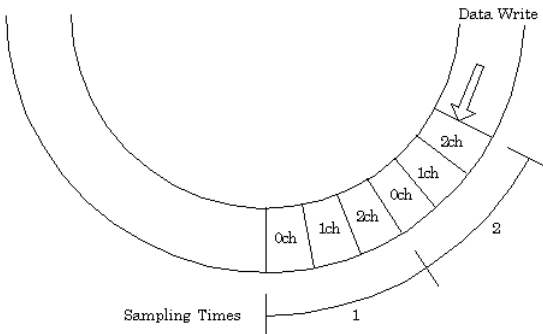

Clock

The sampling clock controls the sampling frequency. You can select either the internal sampling clock, external sampling clock.

- Internal sampling clock

The clock signal from the on-board clock generator is used.

- External sampling clock

The edge of the digital signal input from an external device is used for the sampling clock.

Start Condition

The condition for controlling the start of sampling can be selected from among software, input data comparison, an external trigger. The conditions for controlling the start and stop of sampling are completely independent of each other; they can be set separately.

- Software

The product starts sampling and storing input data to memory immediately after the operation start command is issued.

- Input data comparison

When the operation start command is issued, the product compares the analog signal input through a specified channel to the value of the preset comparison level. If the analog signal satisfies the condition, the product starts storing input data.

Level comparison conditions are set as two conditions: level and direction.

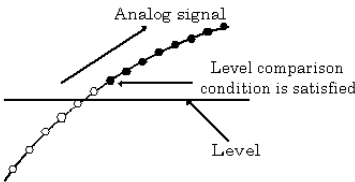

The above sketch shows that the level comparison condition is satisfied in the rising direction.

The start condition is satisfied when the analog signal at the specified channel passes the comparison level in the rising direction. Input data items are stored to memory, starting with those at solid dots.

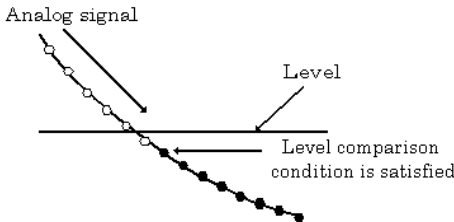

The above sketch shows that the level comparison condition is satisfied in the falling direction.

The start condition is satisfied when the analog signal at the specified channel passes the comparison level in the falling direction. Input data items are stored to memory, starting with those at solid dots.

If you set the level comparison directions to both directions, the start condition is satisfied when the analog signal passes the level both in the rising and falling directions.

- External trigger

The board starts waiting for an external control signal as soon as the operation start command is output. Sampling and data transfer to memory start when the specified edge (rising edge or falling edge) is input from the external control signal.

Stop condition

The condition for controlling the stop of sampling can be selected from among the last sampling count, input data comparison, an external trigger, and software abort.

The product stops sampling whenever an error occurs irrespective of the stop condition setting.

- Last sampling count
The board stops sampling after storing input data to memory for the specified number of times of sampling.
- Input data comparison
Once the board has started sampling, it compares the analog signal input through a specified channel to the value of the preset comparison level. If the analog signal satisfies the condition, the board stops sampling.
Level comparison conditions are set as two conditions: level and direction.

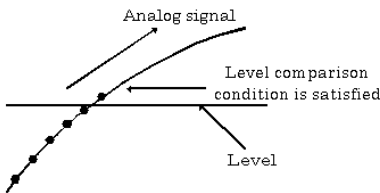

The above sketch shows that the level comparison condition is satisfied in the rising direction.

The stop condition is satisfied when the analog signal at the specified channel passes the comparison level in the rising direction. Input data items are stored to memory, ending until those at solid dots.

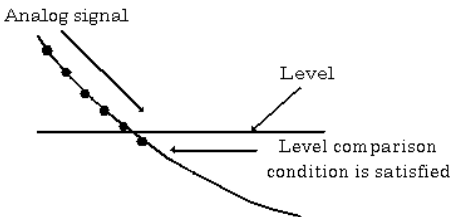

The above sketch shows that the level comparison condition is satisfied in the falling direction.

The stop condition is satisfied when the analog signal at the specified channel passes the comparison level in the falling direction. Input data items are stored to memory, ending until those at solid dots.

If you set the level comparison directions to both directions, the start condition is satisfied when the analog signal passes the level both in the rising and falling directions.

- External trigger
The board starts waiting for an external control signal after the specified number of samples have been performed. Sampling stops when the specified edge (rising edge or falling edge) is input from the external control signal.

Event

”Event” works as a function for reporting the occurrence of a certain board state to the application. The following events can be used in combination depending on the specifications and purpose of the application.

- “AD conversion start condition satisfied” event
This event occurs when the AD conversion start condition is satisfied. The event is nullified when the conversion start condition is “software”.
- Device operation stop event
This event occurs upon the completion of all the operation.
- “Stored specified sampling times” event
This event occurs when sampling has been performed for the number of times set by software. This event can only be used in device buffer mode.
- Overflow event
This event occurs at an attempt to store input data with the memory full.
- Sampling clock error event
This event occurs when conversion stops as an error occurs due to a sampling clock period that is too short.
- AD conversion error event
This event occurs when conversion stops due to an AD conversion error.

2. Starting/Stopping Operation

Sampling is started by the software command.

Once started, sampling can be stopped by the software command at any timing.

3. Monitoring the Status and Acquiring Data

Software commands are used to monitor the operation status of the device and to acquire input data from memory. Status monitoring and data acquisition can be performed even during sampling.

Status

The current state of the device can be checked by obtaining the device status.

The following types of device status are available:

- Device operating
The “device operating” status remains ON, after the execution of the sampling start command until the board completes conversion, aborts operation due to an error, or stops sampling in response to the command.
- Waiting for start trigger
This status remains ON, after the board starts sampling until the start trigger is input, if the conversion start condition is an external trigger or level comparison. The status is set to OFF when the input trigger is input to start conversion.

- Specified sampling data stored
This status is set to ON when input data stored in memory has reached the amount corresponding to the preset number of times of sampling.
If the memory format is FIFO, the status is set to OFF when the amount of input data in the memory falls below the value corresponding to the preset number of times of sampling as data is acquired. Once the status is set to ON when the memory format is ring, it remains ON until it is reset.
- Overflow
An overflow error occurs when an attempt is made to store input data to memory while it has been full of input data.
When the memory format is FIFO, the board stops conversion.
When the memory format is ring, the board continues conversion while overwriting existing data with new one.
- Sampling clock error
This error occurs when the sampling clock period is too short.
- AD conversion error
If the “device operating” status remains ON (without terminating conversion) for an extended period of time, the driver regards that state as an operation error and sets this status to ON. This error stops sampling.

Sampling

Sampling

The number of sampled items of input data stored in memory can be obtained by the software command. This command can only be used in device buffer mode.

Data acquisition

When using the device buffer, the conversion data stored in memory can be retrieved using a software command.

The figure below shows the correspondence between the sampling count and the conversion channel for the conversion data stored in memory.

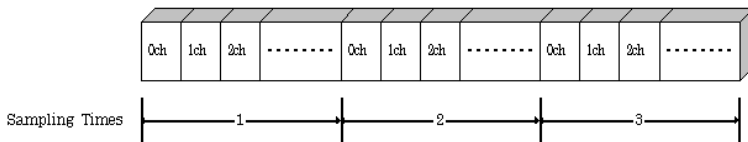

Input data is acquired differently depending on the memory format used.

- Data acquisition in FIFO format

When FIFO memory is used, the oldest data is always read first.

The following sketch shows an image of data acquisition in FIFO format.

When data is acquired from the memory, the free memory space increases by that data size. When data is acquired next, the oldest one of the existing data items is taken from the memory in the same way.

The FIFO memory deletes data once that data is acquired.

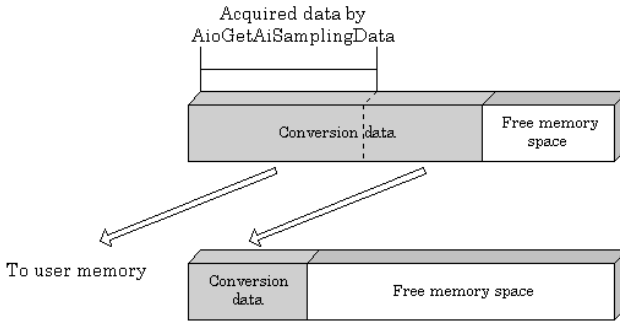

- Data acquisition in ring format

When ring memory is used, data is read always with respect to the current input data write position.

The following sketch shows an image of data acquisition in ring format.

The sampling count obtained is always the number of times of sampling for up to the latest data (shaded portion below).

The larger the number of samples taken, the older the data item acquired first.

As the ring memory retains data even after that data is acquired, you can fetch the same data any number of times.

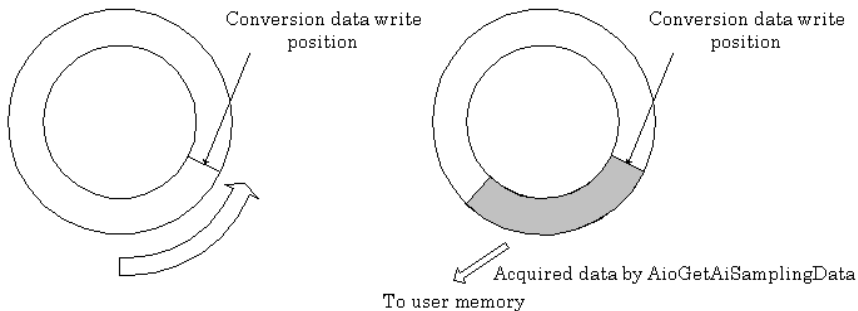

Input data

The following equation represents the relationship between input data and voltage.

Voltage = Input data x (Max. range value – Min. range value) / Resolution + Min. range value

The value of resolution for the 16-bit device is 65536.

The table below shows the relationship between input data and voltage in the ± 10 -V range.

Voltage	Conversion data (16-bit)
+9.99970V	65535
:	:
0.00030V	32769
0V	32768
-0.00030V	32767
:	:
-10.000V	0

Ex.: When input data 49152 is input at a resolution of 16-bit in the ± 10 -V range

$$\text{Voltage} = 49152 \times (10 - (-10)) \div 65536 + (-10)$$

$$= 5.0$$

4.Reset

Various states can be reset by executing the following reset commands:

Status

This command resets the sampling clock error status and AD conversion error status.

Memory

This can only be used when the transfer mode is set to device buffer mode.

This command resets the following memory related states.

- Resets the conversion data in memory.
- Resets the sampling count to 0 when a stop trigger is input.
- Resets the buffer overflow status.
- Resets the status information for the specified data save count.

Digital Input Function

Input bit

Individual digital input points are called input bits.

When the number of input points of a device is 4, the bits are determined as bit 0 - bit 3.

Bit 3	Bit 2	Bit 1	Bit 0
-------	-------	-------	-------

Input in Bits

The state 1 (ON) or 0 (OFF) of each input bit can be obtained by specifying the bit.

Input in Bytes

Individual input bits can be input in byte units.

When the number of input points of the device is 4, the individual input bits are arranged as shown below and the byte data to be input is a value between 0 and 15 depending on the states of the bits.

EX. Input of bit 3 (OFF), bit 2 (ON), bit 1 (OFF), bit 0 (ON)

Byte data = 05(5H)

Bit 3	Bit 2	Bit 1	Bit 0
0(OFF)	1(ON)	0(OFF)	1(ON)

Digital filter

A digital filter can be used on the input bits.

The filter time can be set to "don't use", 1 μ s by software.

Digital Output Function

Output bit

Individual digital output points are called output bits.

When the number of output points of a device is 4, the bits are determined as bit 0 - bit 3.

Bit 3	Bit 2	Bit 1	Bit 0
-------	-------	-------	-------

Output in Bits

The state of each output bit can be changed to ON or OFF by specifying the bit and setting it to 1 or 0.

Output in Bytes

Individual output bits can be output in byte units.

When the number of output points of the device is 4, the individual output bits are arranged as shown below and byte data to be output is a value between 0 and 15.

Ex. Output of bit 3 (ON), bit 2 (OFF), bit 1 (ON), bit 0 (OFF)

Byte data = 10(AH)

Bit 3	Bit 2	Bit 1	Bit 0
1(ON)	0(OFF)	1(ON)	0(OFF)

7. About Hardware

Hardware specification

Table 7.1. Specification (1/2)

Item	Specification
Analog input	
Isolated specification	Un-Isolated
Input type	Single-Ended Input
Number of input channels	8ch
Input range	Bipolar $\pm 10V$
Maximum input rating	$\pm 20V$
Input impedance	1M Ω or more
Resolution	16bit
Non-Linearity error *6	$\pm 12LSB$
Conversion speed	10 μ sec/ch(Max.) *1
Buffer memory	1k Word
Conversion start trigger	Software / external trigger
Conversion stop trigger	Number of sampling times / external trigger/software
External start signal	LVTTL level (Selecting one of the rising / falling / signal edge input to the DI00-pin by the software)
External stop signal	LVTTL level (Selecting one of the rising / falling / signal edge input to the DI01-pin by the software)
External clock signal	LVTTL level (Selecting the rising / falling to the DI02-pin by the software)
Digital I/O	
Number of input channels	Un-Isolated input 4ch (LVTTL positive logic) *2*3
Number of output channels	Un-Isolated output 4ch (LVTTL positive logic)
USB	
Bus specification	USB Specification 2.0/1.1 standard
USB transfer rate	12Mbps (Full-speed), 480Mbps (High-speed) *4
Power supply	Bus power

Table 7.1. Specification (2/2)

Item	Specification
Common section	
Connector	14 pin (screw-terminal) plug header
Number of terminals used at the same time	127 terminals (Max.) *5
Power consumption (Max.)	5VDC 350mA
Operating condition	0 - 50°C, 10 - 90%RH(No condensation)
External dimensions (mm)	64(W) x 62(D) x 24(H) (exclusive of protrusions)
Weight	90g (Not including the USB cable, attachment)
Attached cable	USB cable 1.8m
Compatible wires	AWG28 - 16

- *1 Conversion speed for the A/D converter. The minimum executable sampling cycle depends on the operating condition of the terminal.
- *2 You cannot use both the DI00 / DI01 / DI02-pin of digital input feature and the external start / stop signal / external clock input simultaneously.
- *3 Each input accepts TTL (5VDC) level signals.
- *4 The USB transfer speed depends on the host PC environment used (OS and USB host controller).
- *5 As a USB hub is also counted as one device, you cannot just connect 127 USB terminals.
- *6 The non-linearity error means an error of approximately 0.1% occurs over the maximum range at 0°C and 50°C ambient temperature.

External dimensions

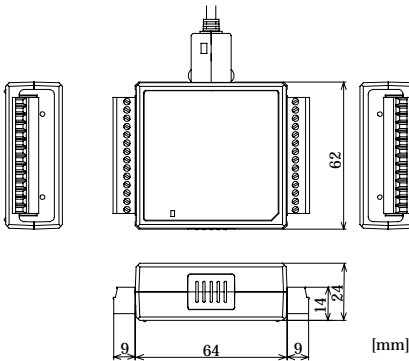
**Figure 7.1. External dimensions**

Block Diagram

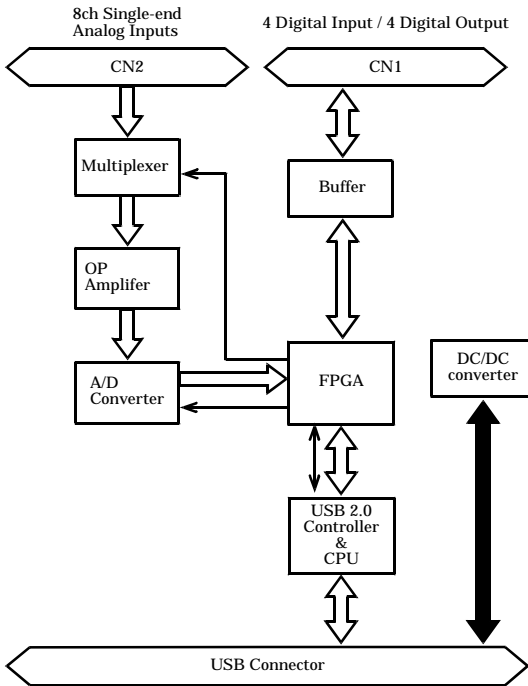

Figure 7.2. Block Diagram

Control Signal Timings

Control Signal Timings for Analog Input

Figures 7.3, 7.4, 7.5, and Table 7.2 show the control signal timings for the analog input function.

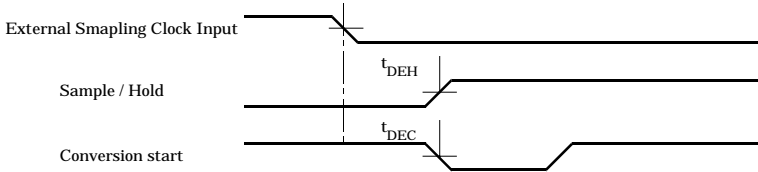

Figure 7.3. Timing Chart of External Sampling Clock

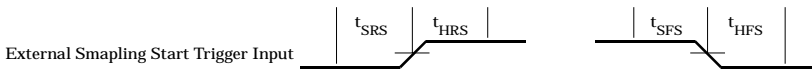

Figure 7.4. Timing Chart of Sampling Start Control Signal

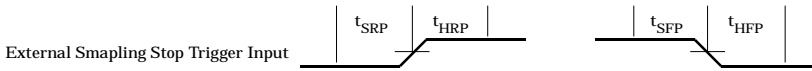

Figure 7.5. Timing Chart of Sampling Stop Control Signal

Table 7.2. Control Signal Timings

Parameter	Symbol	Time	Unit
Delay from external sampling clock cycle to first channel hold	t_{DEH}	100	nsec
Delay from external sampling clock cycle to first channel A/D conversion start pulse	t_{DEC}	100	nsec
Set up time of sampling start (Rising edge)	t_{SRS}	100	nsec
Hold time of sampling start (Rising edge)	t_{HRS}	100	nsec
Set up time of sampling start (Falling edge)	t_{SFS}	100	nsec
Hold time of sampling start (Falling edge)	t_{HFS}	100	nsec
Set up time of sampling stop (Rising edge)	t_{SRP}	100	nsec
Hold time of sampling stop (Rising edge)	t_{HRP}	100	nsec
Set up time of sampling stop (Falling edge)	t_{SFP}	100	nsec
Hold time of sampling stop (Falling edge)	t_{HFP}	100	nsec



CAUTION

The times listed in Table 7.2 are for standard operating conditions.

About Calibration

Although this product is calibrated before shipping, you can use the calibration program to calibrate analog input yourself.

Starting the calibration program

Click the [Calibration] button on the property page for the device to start the calibration program.

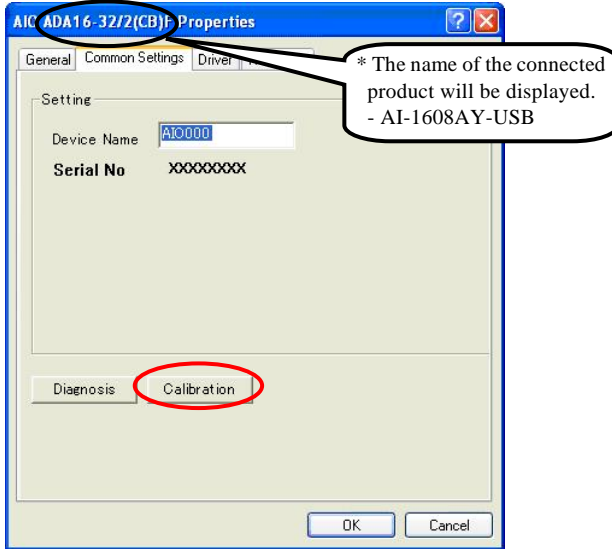

* The product-specific number will be displayed as the serial number.

Proceed with connecting the calibration equipment and performing the calibration in accordance with the instructions displayed by the calibration program.

Analog input calibration

Analog input calibration requires a reference voltage generator.

As the analog input has 16-bit resolution, use a reference voltage generator with a precision of at least 5 digits after the decimal point.

Calibrate one channel only for each range that you use.

Factory setting

You can use the calibration program to restore the factory calibration settings.

If the prescribed performance cannot be achieved, contact your retailer.

AI-1608AY-USB

User's Guide

CONTEC CO., LTD.

June 2006 Edition

3-9-31, Himesato, Nishiyodogawa-ku, Osaka 555-0025, Japan

Japanese <http://www.contec.co.jp/>

English <http://www.contec.com/>

Chinese <http://www.contec.com.cn/>

No part of this document may be copied or reproduced in any form by any means without prior written consent of CONTEC CO., LTD. [06202006]

[04172006]

Management No. A-51-221

[06202006_rev2]

Parts No. LYFZ731